

# POLİGONEL DİFÜZÖRLER

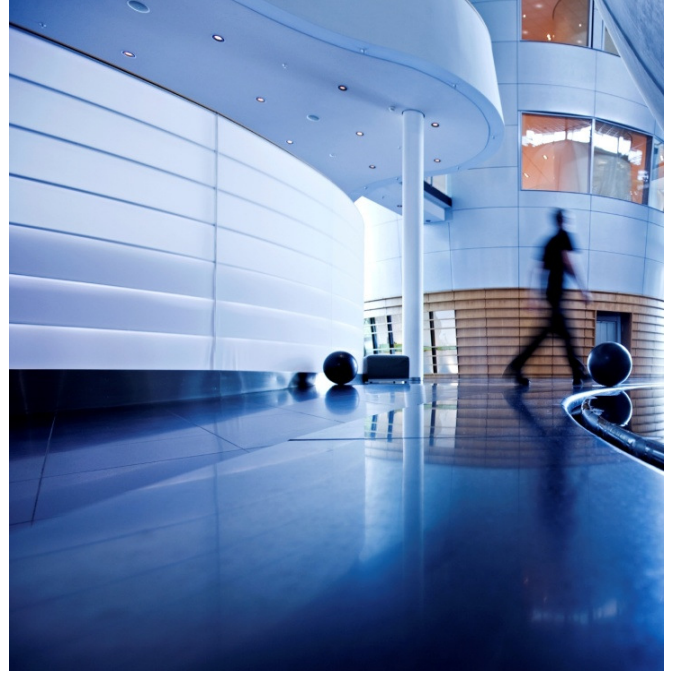

**ELEKTROTEKNİK**

# POLİGONEL DİFÜZÖRLER

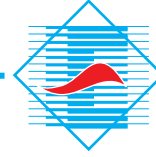

Poligonel difüzörler rooftop cihazlarının üflemesinde kullanılan ve en ideal sonuç veren difüzör grubudur.

## Kullanım Alanları

- Alışveriş Merkezleri
- Süpermarketler
- Mağazalar
- Fabrika Binaları
- Yüzme Havuzları
- Spor Salonları
- Toplantı ve Konferans Salonları
- Havaalanları, Terminaller



- Poligonel difüzörler geniş mekan uygulamalarında ideal sonuç verir.
- Düşük basınç kayıplarıyla yüksek atış hızı ve mesafesi sağlanabilir.
- Tek bir sistem hem ısıtmada hem soğutmada kullanılabilir.
- İçerisinde bulunan yönlendiriciler ile her bir difüzörden eşit miktarda hava dağılmasına olanak sağlar
- Galvaniz çelik, alüminyum ve paslanmaz çelikten imal edilebilir
- Elektrostatik fırın boyalı olarak kullanılabilir. Fırın boya rengi RAL kataloğundan belirlenir.

- Katalogda bulunan ürünler haricinde, proje bazlı olarak istenilen ölçü ve şekilde özel imalat yapılabilmektedir.
- Ayrıca ihtiyaç olan debi ve atış mesafesine en uygun olan difüzör, seçim programıyla seçilip kullanılabilir.

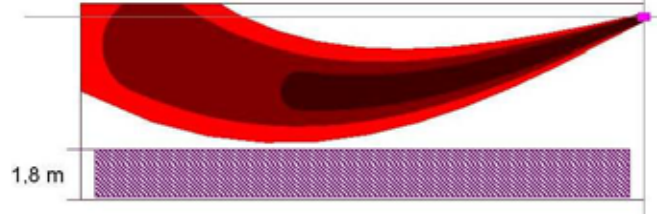

Project	<Not defined>								
Zone	<Not defined>								
Room	<Not defined>								
Qtot	=	2286,0m³/h	635,0 l/s	0,8 Vol/h					
Qo	=	2286,0m³/h	635,0 l/s						
Qind	=	95200,2m³/h	26444,5 l/s	34,0 Vol/h					
dT	=	8,0°C							
dTx	=	0,3°C							
P	=	5266,15 kcal/h	6,12 kW	15,29 W/m²	41,64 Qtot				
dP	=	62,8 Pa	6,4 H2O						
XL	=	20,00m							
Xa	=	20,00m							
Vk	=	10,36 m/s							
Ak	=	0,06128 m²							
Vz max	=	0,72 m/s							
Vr	=	0,51 m/s							
Vt	=	0,72 m/s							
Lw	=	47,6 dB(A)	43,9 NR	41,5 NC					
Lp	=	30,8 dB(A)	27,1 NR	24,7 NC					
fHz	=	63	125	250	500	1000	2000	4000	8000
Lw dB	=	55,1	50,1	46,9	44,8	43,9	37,1	30,1	24,6

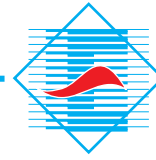

## POLİGONEL DİFÜZÖRLER

### POLİ-SJD/A8 , B8

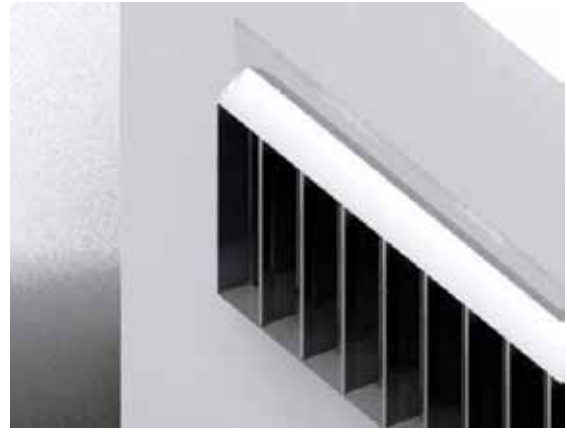
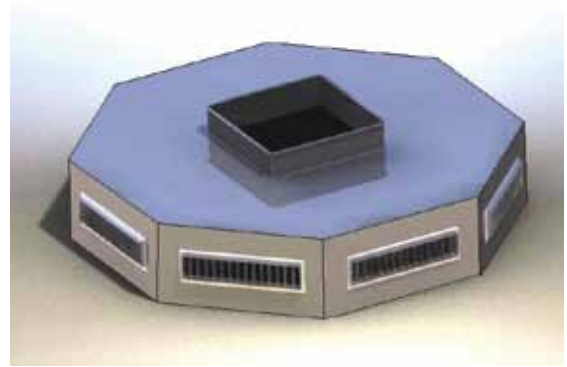
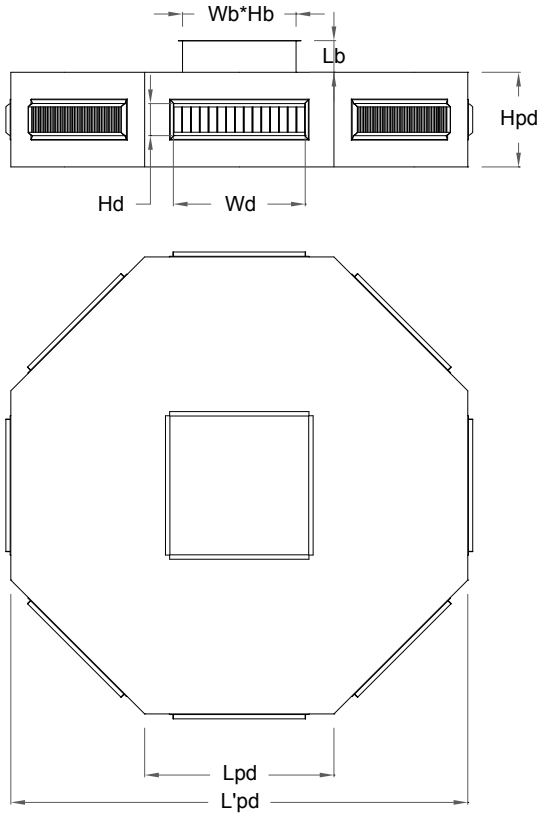

	POLİ-SJD/A8				POLİ-SJD/B8			
	1250	1100	1000	800	1750	1500	1250	1000
Lpd	1250	1100	1000	800	1750	1500	1250	1000
L'pd	3020	2655	2415	1930	4225	3620	3020	2415
Hp	450	450	450	450	750	750	750	750
Wb	800	700	600	500	1200	1100	1000	900
Hb	800	700	600	500	1200	1100	1000	900
Lb	250	250	250	250	250	250	250	250
Wd	900	750	600	450	1200	1050	750	600
Hd	160	160	160	160	265	265	265	265
Min. Debi	6400	6000	4800	4000	24000	20000	16000	13600
Max. Debi	22400	18400	15200	10400	56000	48000	36000	28000

•Ölçüler mm,

\*Debi birimi m<sup>3</sup>/h'tır.

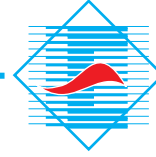

## POLİGONEL DİFÜZÖRLER

### POLİ-SJD/ A6 , B6

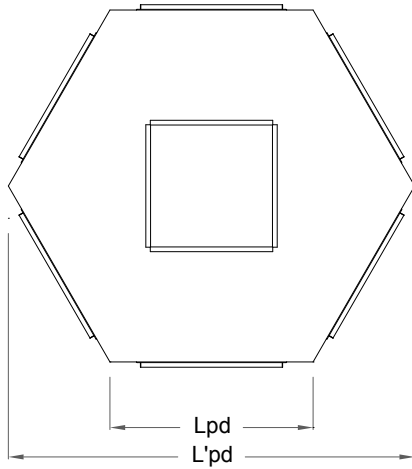
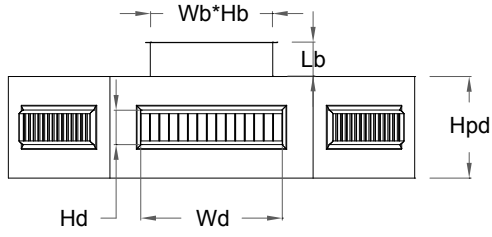

	POLİ-SJD/A6				POLİ-SJD/B6			
	1250	1100	1000	800	1750	1500	1250	1000
Lpd	1250	1100	1000	800	1750	1500	1250	1000
L'pd	2500	2200	2000	1600	3500	3000	2500	2000
Hpd	450	450	450	450	750	750	750	750
Wb	700	600	500	400	1000	900	800	700
Hb	700	600	500	400	1000	900	800	700
Lb	250	250	250	250	250	250	250	250
Wd	900	750	600	450	1200	1050	750	600
Hd	160	160	160	160	265	265	265	265
Min. Debi	4800	4500	3600	3000	18000	15000	12000	10200
Max. Debi	16800	13800	11400	7800	42000	36000	27000	21000

•Ölçüler mm,  
\*Debi birimi m<sup>3</sup>/h'tir.

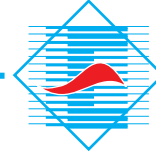

## POLİGONEL DİFÜZÖRLER

### POLİ-JN/ A8 , B8

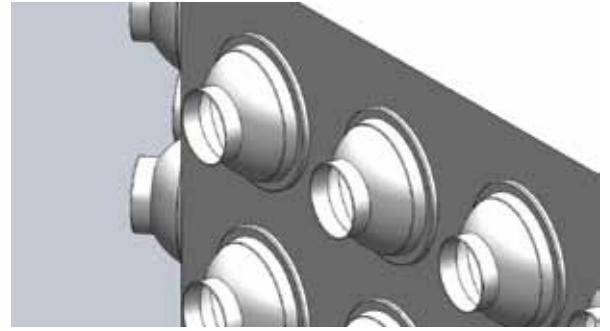
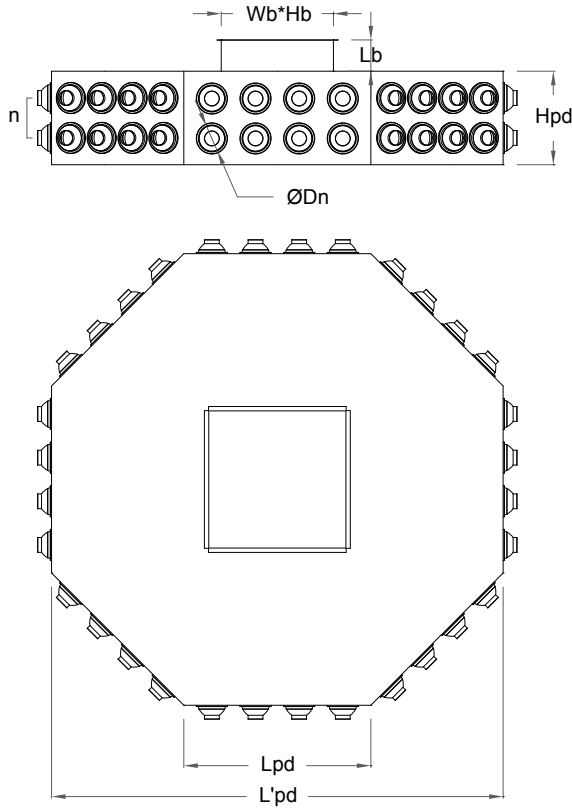

	POLİ-JN/A8				POLİ-JN/B8			
	1250	1100	1000	800	1750	1500	1250	1000
Lpd	1250	1100	1000	800	1750	1500	1250	1000
L'pd	3020	2655	2415	1930	4225	3620	3020	2415
Hp	450	450	450	450	750	750	750	750
Wb	600	500	400	400	1200	1100	1000	900
Hb	600	500	400	400	1200	1100	1000	900
Lb	250	250	250	250	250	250	250	250
Dn	160	160	160	160	200	200	200	200
Sıra Sayısı (n)	1	1	1	1	2	2	2	,2
Nozul Sayısı	5	4	3	2	10	8	6	4
Min. Debi	1600	1280	960	640	4800	3840	2880	1920
Max. Debi	12000	9600	7200	4800	56000	44800	33600	22400

\*Ölçüler mm,

\*Debi birimi m<sup>3</sup>/h'tır.

\*Nozul sayıları bir kenardaki sayılardır.

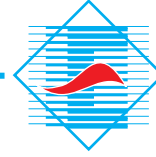

## POLİGONEL DİFÜZÖRLER

### POLİ-JN/ A6 , B6

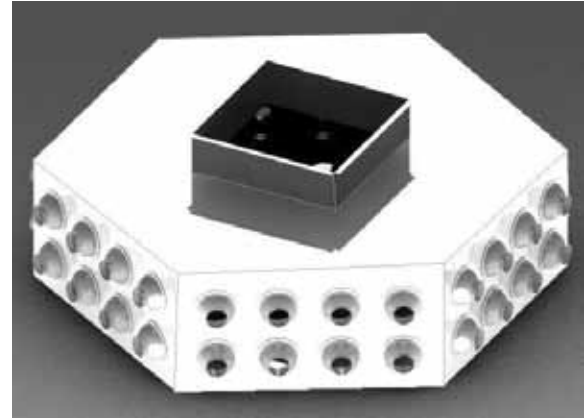
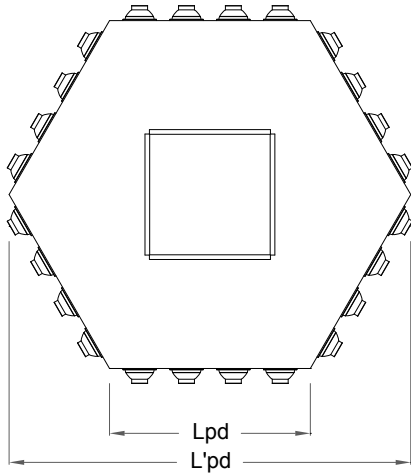
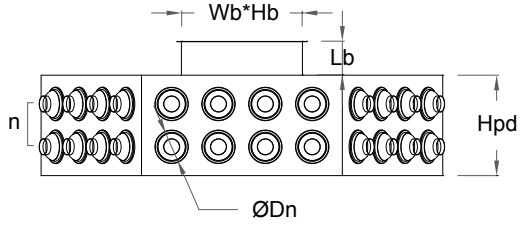

	POLİ-JN/A6				POLİ-JN/B6			
	1250	1100	1000	800	1750	1500	1250	1000
Lpd	1250	1100	1000	800	1750	1500	1250	1000
L'pd	2500	2200	2000	1600	3500	3000	2500	2000
Hpd	450	450	450	450	750	750	750	750
Wb	500	400	400	300	1000	900	800	700
Hb	500	400	400	300	1000	900	800	700
Lb	250	250	250	250	250	250	250	250
Dn	160	160	160	160	200	200	200	200
Sıra Sayısı (n)	1	1	1	1	2	2	2	2
Nozul Sayısı	5	4	3	2	10	8	6	4
Min. Debi	1200	960	720	480	3600	2880	2160	1440
Max. Debi	9000	7200	5400	3600	42000	33600	25200	16800

•Ölçüler mm,

\*Debi birimi m<sup>3</sup>/h'tır.

\*Nozul sayıları bir kenardaki sayılardır.

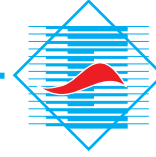

## POLİGONEL DİFÜZÖRLER

### POLİ-TD/ 6 , 8

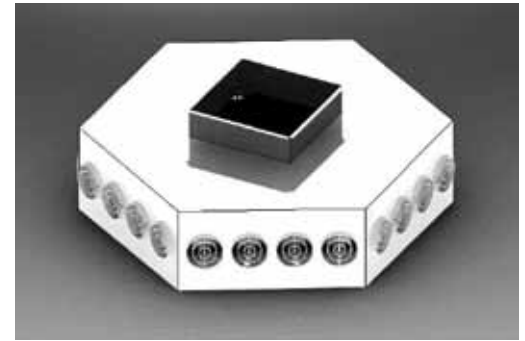
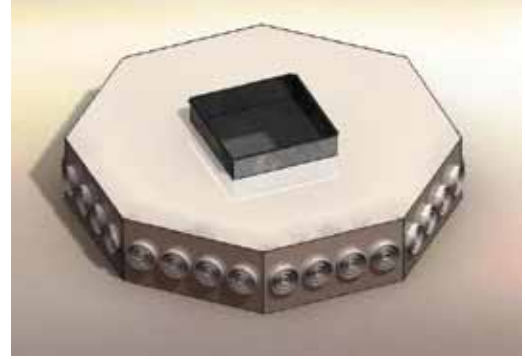
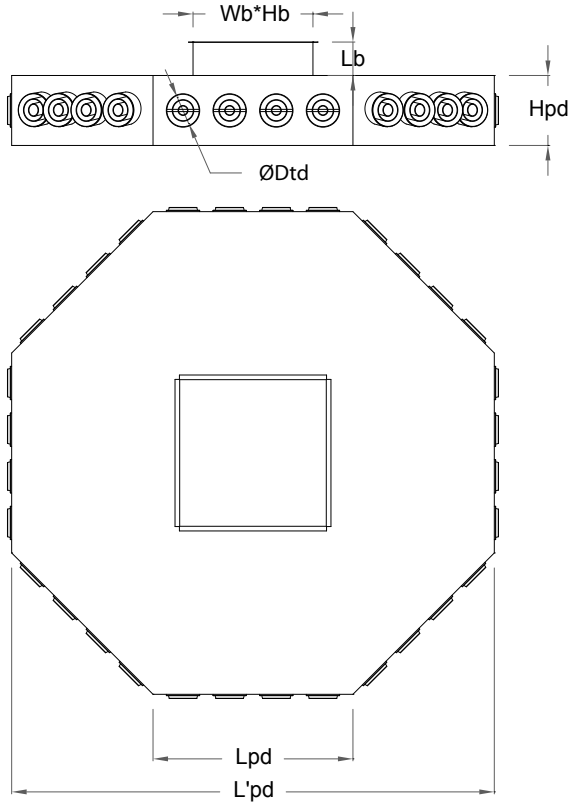

	POLİ-TD/6				POLİ-TD/8			
	1250	1100	1000	800	1250	1100	1000	800
Lpd	1250	1100	1000	800	1250	1100	1000	800
L'pd	2500	2200	2000	1600	2500	2200	2000	1600
Hp	450	450	450	450	450	450	450	450
Wb	800	700	600	500	900	800	700	600
Hb	800	700	600	500	900	800	700	600
Lb	250	250	250	250	250	250	250	250
Dtn	200	200	200	200	200	200	200	200
Sıra Sayısı (n)	1	1	1	1	1	1	1	1
T.D. Sayısı	5	4	3	2	5	4	3	2
Debi	20100	16080	12060	8040	26800	21440	16080	10720

•Ölçüler mm.

\*Debi birimi m<sup>3</sup>/h'tır.

\*Teleskopik Difüzör sayıları bir kenardaki sayılardır.

\*Teleskopik Difüzör çıkış hızları 6 m/s'dir.





## ELEKTROTEKNİK

Klima Sanayi ve Ticaret A.Ş.



**Fabrica / Factory-İstanbul**  
Atatürk Cad. Çağatay Sok. No:3 Sarıgazi  
Sancaktepe 34785 İstanbul/TURKEY  
Tel / Phone :+90 216 499 14 64 (pbx)  
Faks / Fax :+90 216 499 66 19

x



**Fabrica / Factory-Eskişehir**  
Eskişehir OSB Şehitler Bulvarı No:29/A  
23110 Eskişehir/TURKEY  
Tel / Phone :+90 222 236 20 40  
Faks / Fax :+90 222 236 20 49



**Fabrica / Factory-Eskişehir**  
Eskişehir OSB Şehitler Bulvarı No:29/B  
23110 Eskişehir/TURKEY  
Tel / Phone :+90 222 236 20 40  
Faks / Fax :+90 222 236 20 49



**Fabrica / Factory-Eskişehir**  
Eskişehir OSB 21.Cad. No:15  
23110 Eskişehir/TURKEY  
Tel / Phone :+90 222 236 20 40  
Faks / Fax :+90 222 236 20 49

x