

# SWRIL DIFÜZÖRLER DSW 05

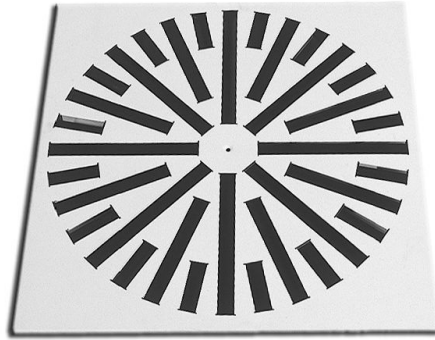

**ELEKTROTEKNİK**

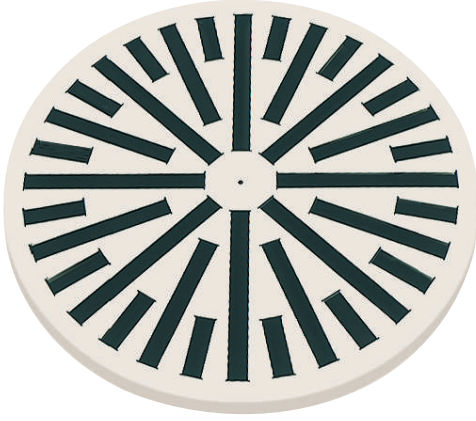
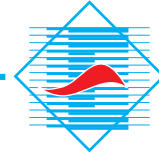

## SWİRL DİFÜZÖRLER (DSW 05)

Asma tavan uygulamaları için dizayn edilmiş olup, asma tavan yüksekliği 2-4 m olan mekanlar için uygundur. Dekoratif dizaynı ile mükemmel çözümler oluşturur. Mimari açıdan tercih edilir.

Bu tip difüzörler farklı konfor ihtiyaçlarının istendiği mekanlar için çok müsaittir. Yönlendirme kanatları uzak mesafeler için ayarlanabilir. Kanat yönleri değiştirilerek hava jeti yataydan dikeye doğru yönlendirilebilir. Kanak ayarları montajdan önce veya sonra yapılabilir. Basınç kaybı ve ses seviyesi bütün kanat yönleri için sabit kalır. Hem maksimum hem de minimum hava debilerinde sabit hava jeti sağlanır. Hız kontrolü için düz veya zıt kanatlı damperle beraber uygulanabilir.

### MALZEME:

Tamamen sac malzemeden imal edilmiş olup elektrostatik fırın boyalı olarak istenilen renklerde boyanabilir. Fırın boya rengi RAL toz boya kataloğundan belirlenir.

### MONTAJ:

Genellikle plenum box ile beraber kullanılır. Box içindeki damper ile hava debisi kolayca ve doğru olarak ayarlanabilir. Bu difüzörler merkezinde bulunan delikten plenum box içindeki köprüye civatalı bağlantı ile monte edilmekle beraber kare tip difüzörler asma tavan taşıyıcılarını sıkı geçme şeklindeki montaja uygun olarak da imal edilebilir.

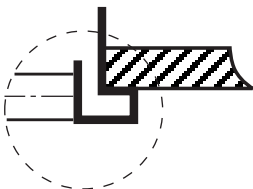
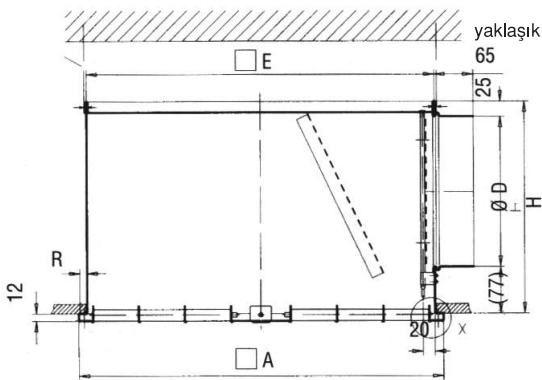

### PRATİK SEÇİM TABLOSU VE KUTU ÖLÇÜLERİ

Tip	A mm	E mm	H mm	ØD mm	R mm	Vmin m <sup>3</sup> /h	Vmax m <sup>3</sup> /h	V 40dB(A) ses seviyesi için debiler m <sup>3</sup> /h
310	308	290	260	158	8	155	410	280
400	398	370	260	158	12	170	490	330
500	498	470	300	198	12	300	960	540
600	598	570	350	248	12	410	1430	810
625	623	570	350	248	24	410	1430	810
800	798	770	455	353	12	610	2600	1200

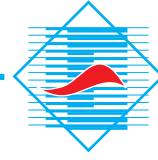

# SWİRL DİFÜZÖRLER (DSW 05)

Kanatları yönlendirerek havayı istediğimiz yöne kanalize ederiz.

Kanat pozisyonu 1

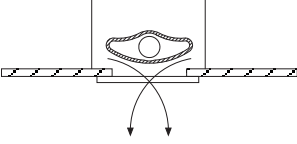

Kanat pozisyonu 2

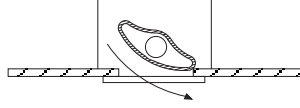

Havayı döndürerek üfleme:

- Kanat pozisyonu 1
- Kanat pozisyonu 2

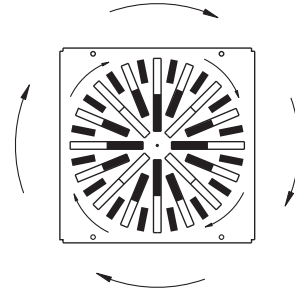
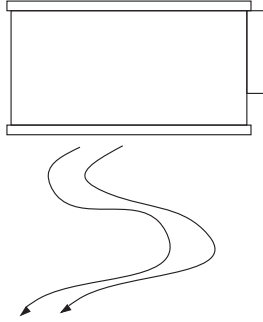

Havayı tek yöne yönlendirmek:

- ▨ Kanat pozisyonu 2, Sol
- Kanat pozisyonu 2, Sağ
- ⊗ Kapalı

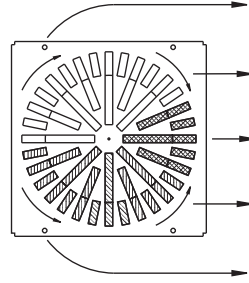
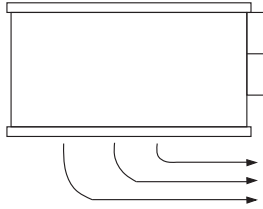

Havayı iki yöne yönlendirmek:

- ▨ Kanat pozisyonu 2, Sol
- Kanat pozisyonu 2, Sağ
- ⊗ Kapalı

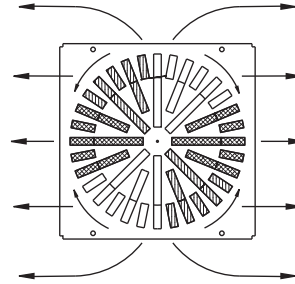
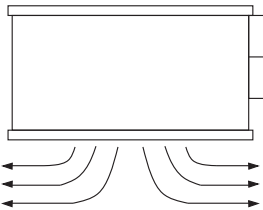

Hava geçiş yönleri kısmi kapatılmış:

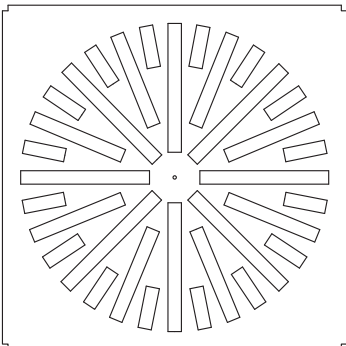
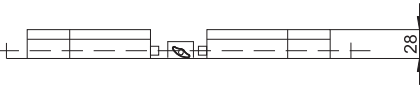

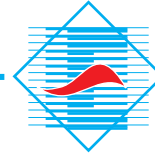

## SWİRL DİFÜZÖRLER (DSW 05)

DSW-05/300 Y



DSW-05/300 K

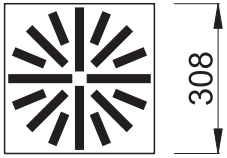

DSW-05/400 Y

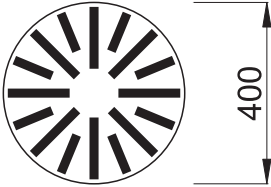

DSW-05/400 K

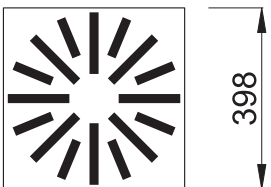

Plenum box kullanım  
Ses seviyesi ve basınç kaybı diyagramı

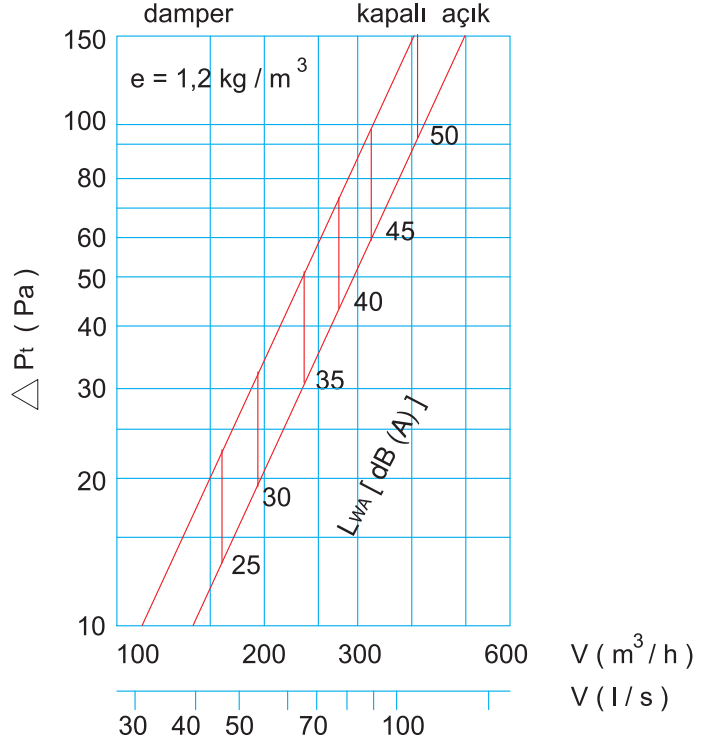

Plenum box kullanım  
Ses seviyesi ve basınç kaybı diyagramı

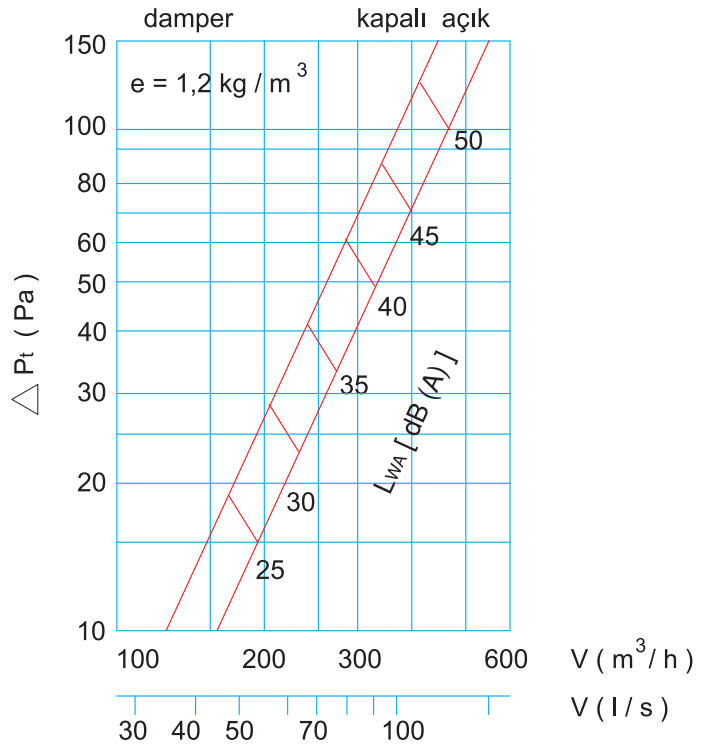

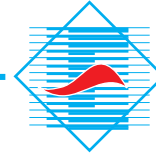

## SWİRL DİFÜZÖRLER (DSW 05)

DSW-05 / 500 Y

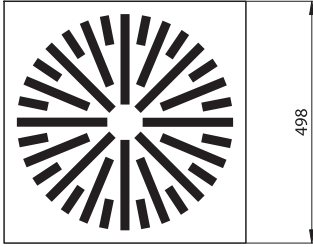

DSW-05 / 500 K

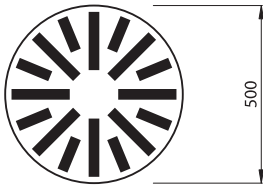

DSW-05 / 600 Y

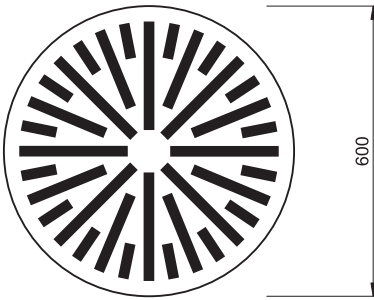

DSW-05 / 600 K

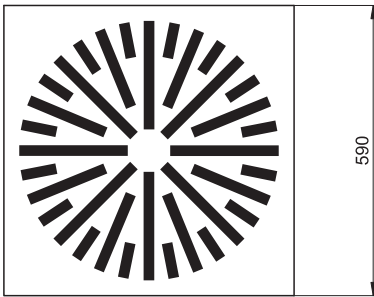

Plenum boxlu kullanım  
Ses seviyesi ve basınç kaybı diyagramı

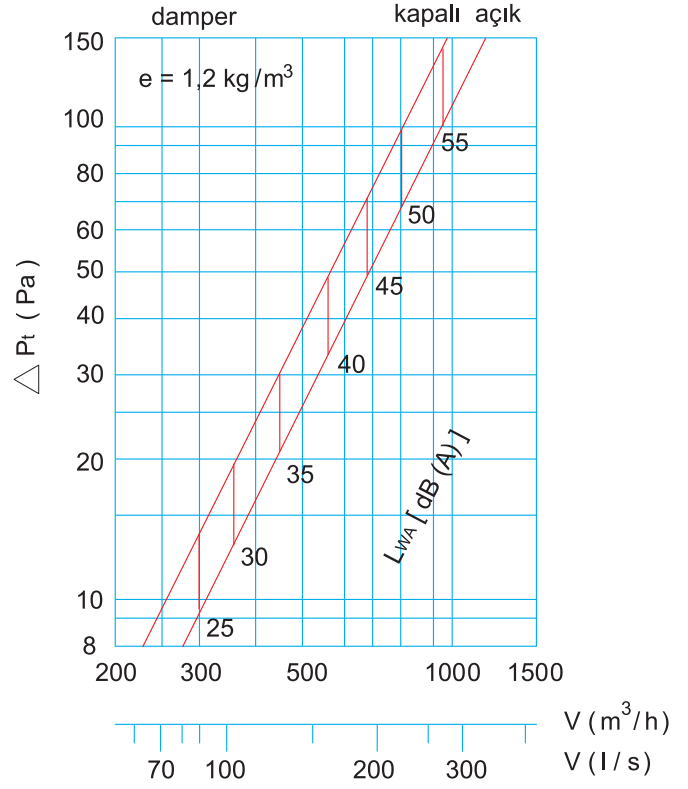

Plenum boxlu kullanım  
Ses seviyesi ve basınç kaybı diyagramı

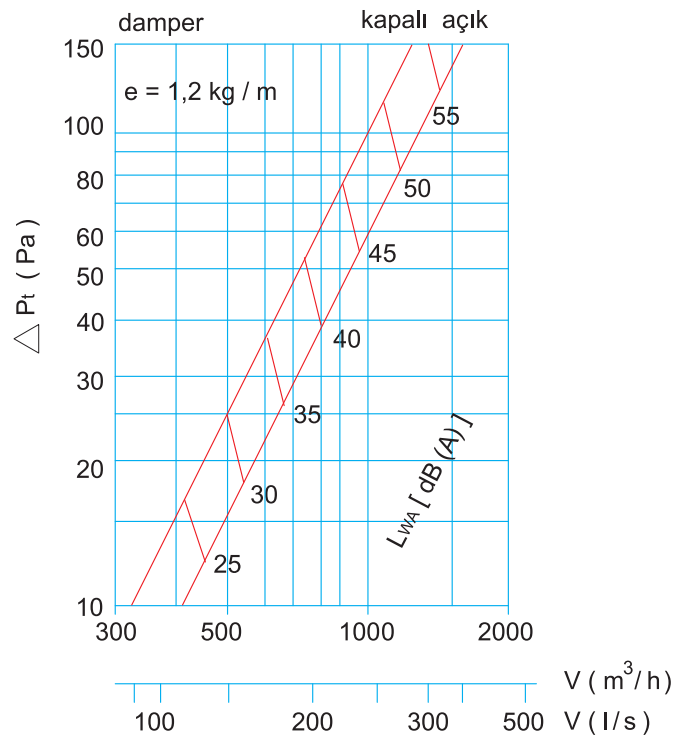

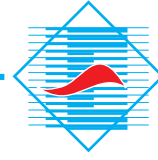

# SWİRL DİFÜZÖRLER (DSW 05)

DSW-05 / 800 Y

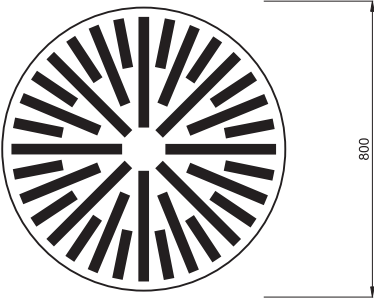

DSW-05 / 800 K

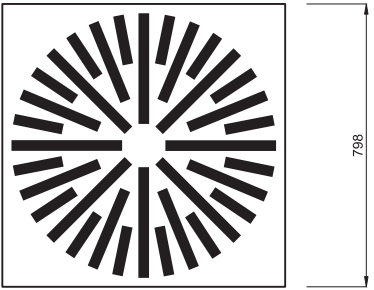

Plenum boxlu kullanım  
Ses seviyesi ve basınç kaybı diyagramı

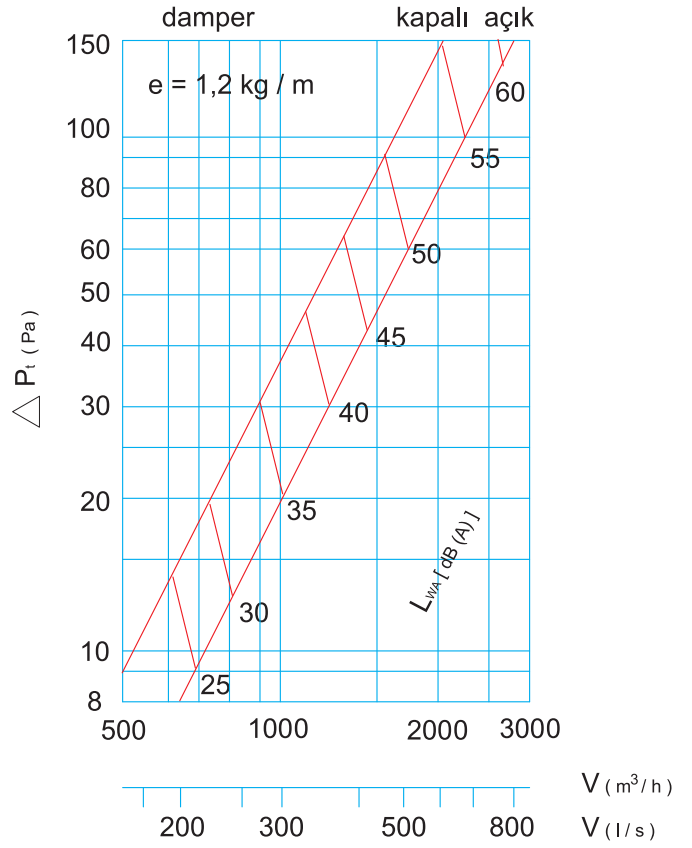

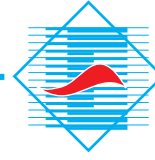

# SWİRL DİFÜZÖRLER (DSW 05)

## UZAK NOKTA HAVA HIZI DİYAGRAMI

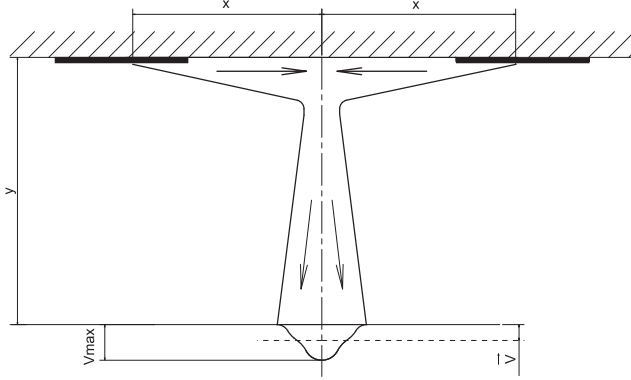

- x (m)=Yatay jet yolu  
y (m)=Düsey jet yolu  
y<sub>max</sub> (m/s)=Maksimum nihai jet hızı  
v (m/s)=Ortalama nihai jet hızı  
v=v<sub>max</sub> x 0.5

DSW05 / 300

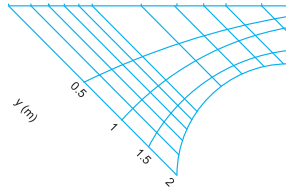
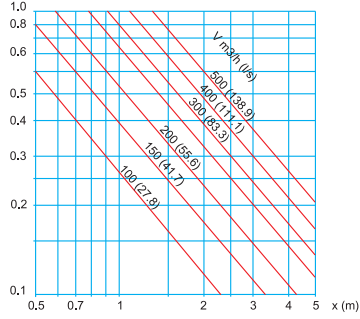

DSW05 / 400

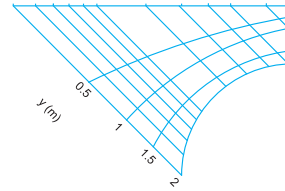
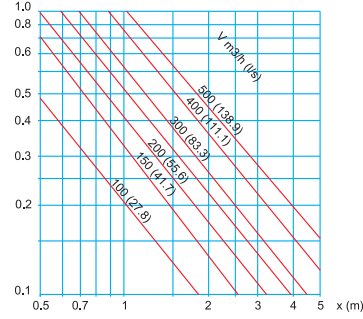

DSW05 / 500

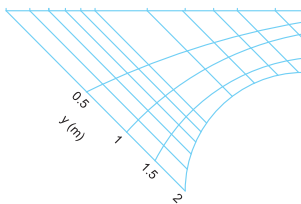
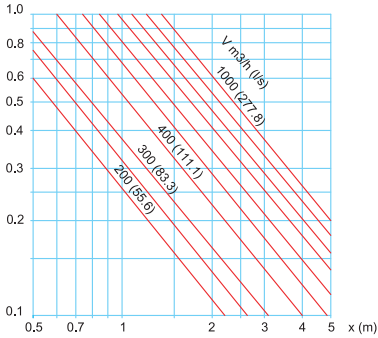

DSW05 / 600

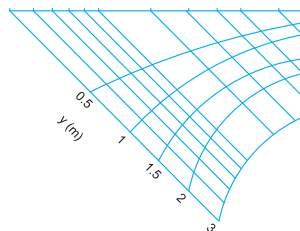
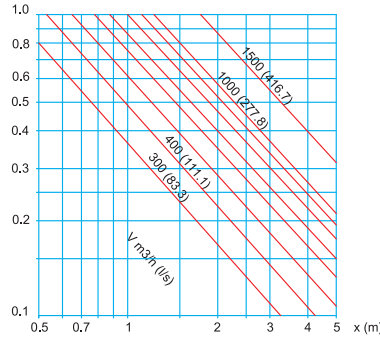

DSW05 / 800

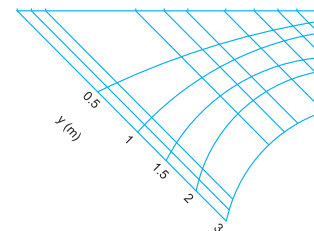
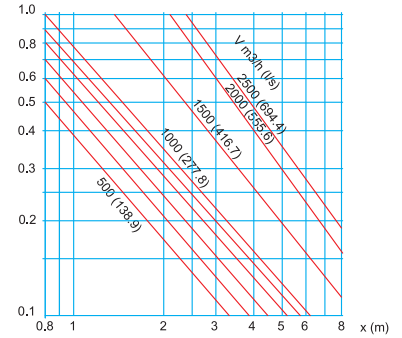

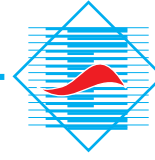

# SWİRL DİFÜZÖRLER (DSW 05)

## YATAY ÜFLEME MESAFESİ

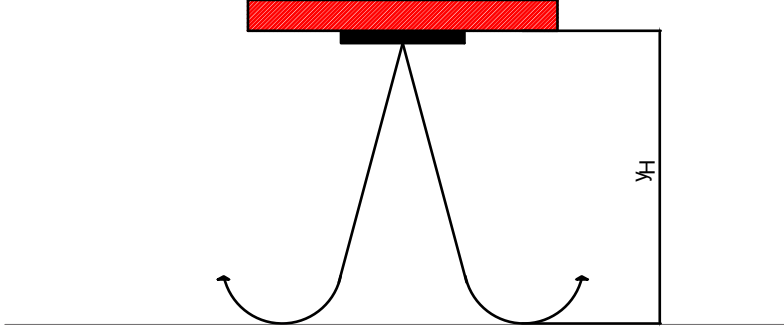

### DSW05 / 300

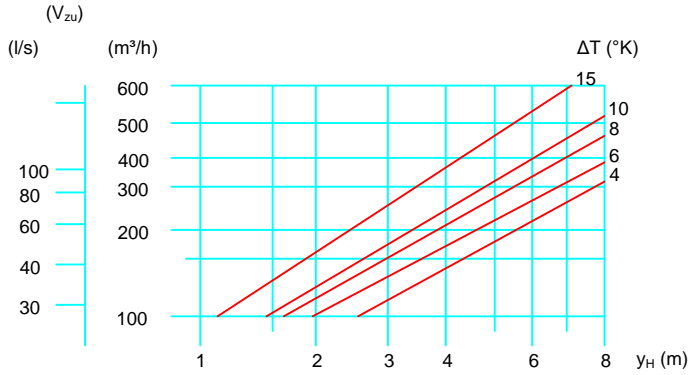

### DSW05 / 400

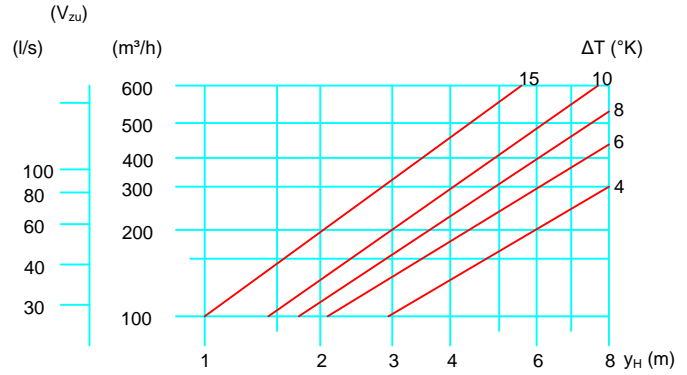

### DSW05 / 500

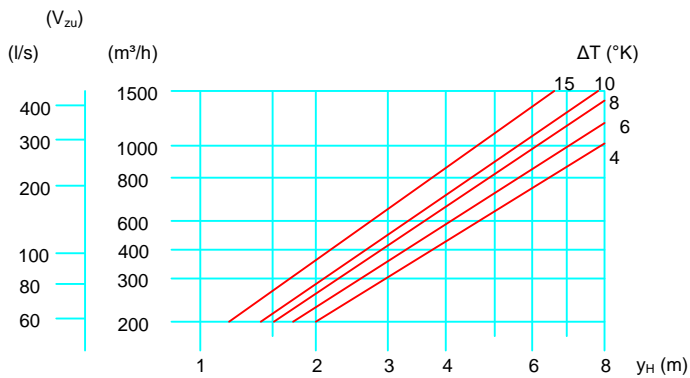



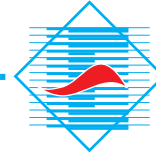

# SWİRL DİFÜZÖRLER (DSW 05)

## YATAY ÜFLEME MESAFESİ

### DSW05 / 600

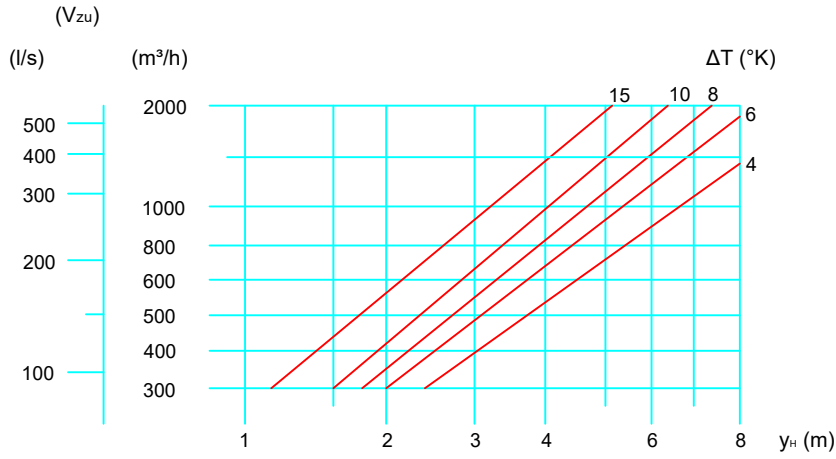

### DSW05 / 800

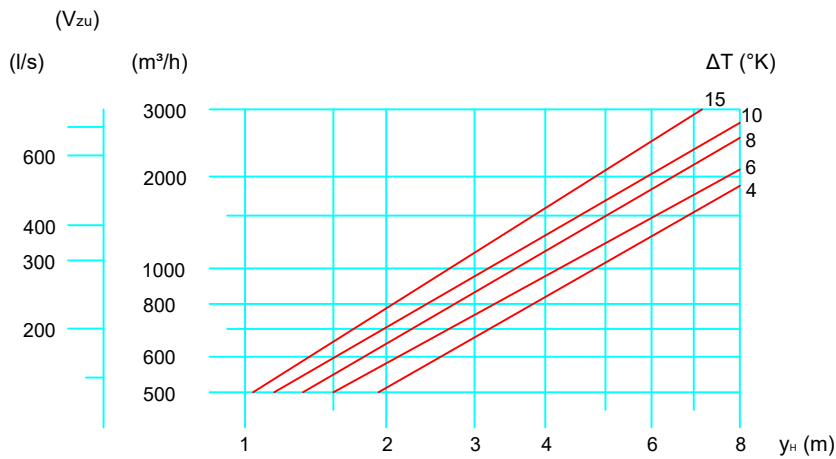

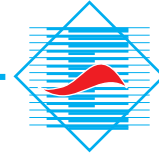

## REFERANSLAR



Quasar İstanbul



İzmir Adnan Menderes Havalimanı



Paladium Tower



Emaar Square İstanbul  
Konut Blokları



Samsun Sheraton



Bodrum Dış Hatlar Yeni  
Terminal Ek Mahalleri



Varyap Meridyen

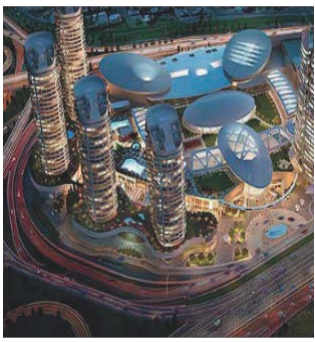

Mall of İstanbul



İstanbulbloom

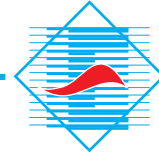

## REFERANSLAR



**Torun Center İstanbul**

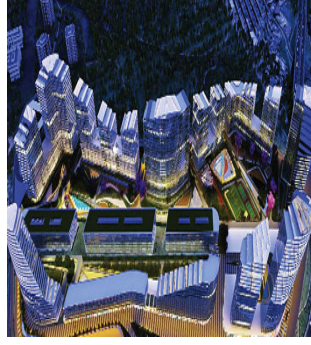

**Batışehir**

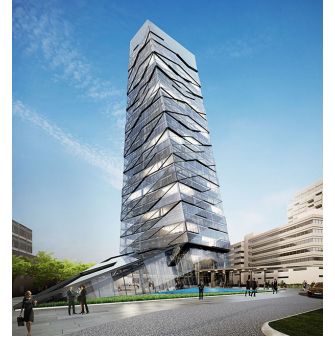

**Nida Kule Levent**



**Nida Kule Seyrantepe**



**İstanbul Atatürk Havalimanı**



**Zorlu Center AVM**



**Akasya Acıbadem**



**İş Kuleler Levent**

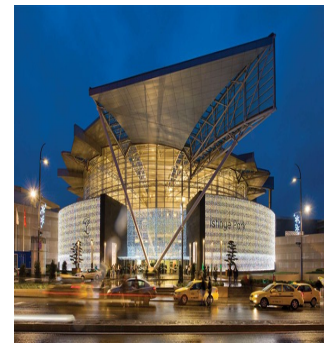

**İstinye Park AVM**

 **ELEKTROTEKNİK**  
Klima Sanayi ve Ticaret A.Ş.



**Fabrika / Factory - İstanbul**

Atatürk Cad. Çağatay Sokak  
No:3 Sarıgazi Sancaktepe / İstanbul / TURKEY 34785  
Tel. / Phone : +90 216 499 14 64 (Pbx)  
Faks / Fax : +90 216 499 66 19



**Fabrika / Factory - Eskişehir**

Eskişehir OSB  
Şehitler Bulvarı No:29/A Eskişehir / TURKEY  
Tel. / Phone : +90 222 236 20 40  
Faks / Fax : +90 222 236 20 49



**Fabrika / Factory - Eskişehir**

Eskişehir OSB  
Şehitler Bulvarı No:29/B Eskişehir / TURKEY  
Tel. / Phone : +90 222 236 20 40  
Faks / Fax : +90 222 236 20 49



**Fabrika / Factory - Eskişehir**

Eskişehir OSB  
Organize San. Bölgesi 21. Cad. No: 15  
Tel. / Phone : +90 222 236 20 40  
Faks / Fax : +90 222 236 20 49